

Foot-switch
Series F1

Description **F1-U1Z UN**

Article number **6061600006**

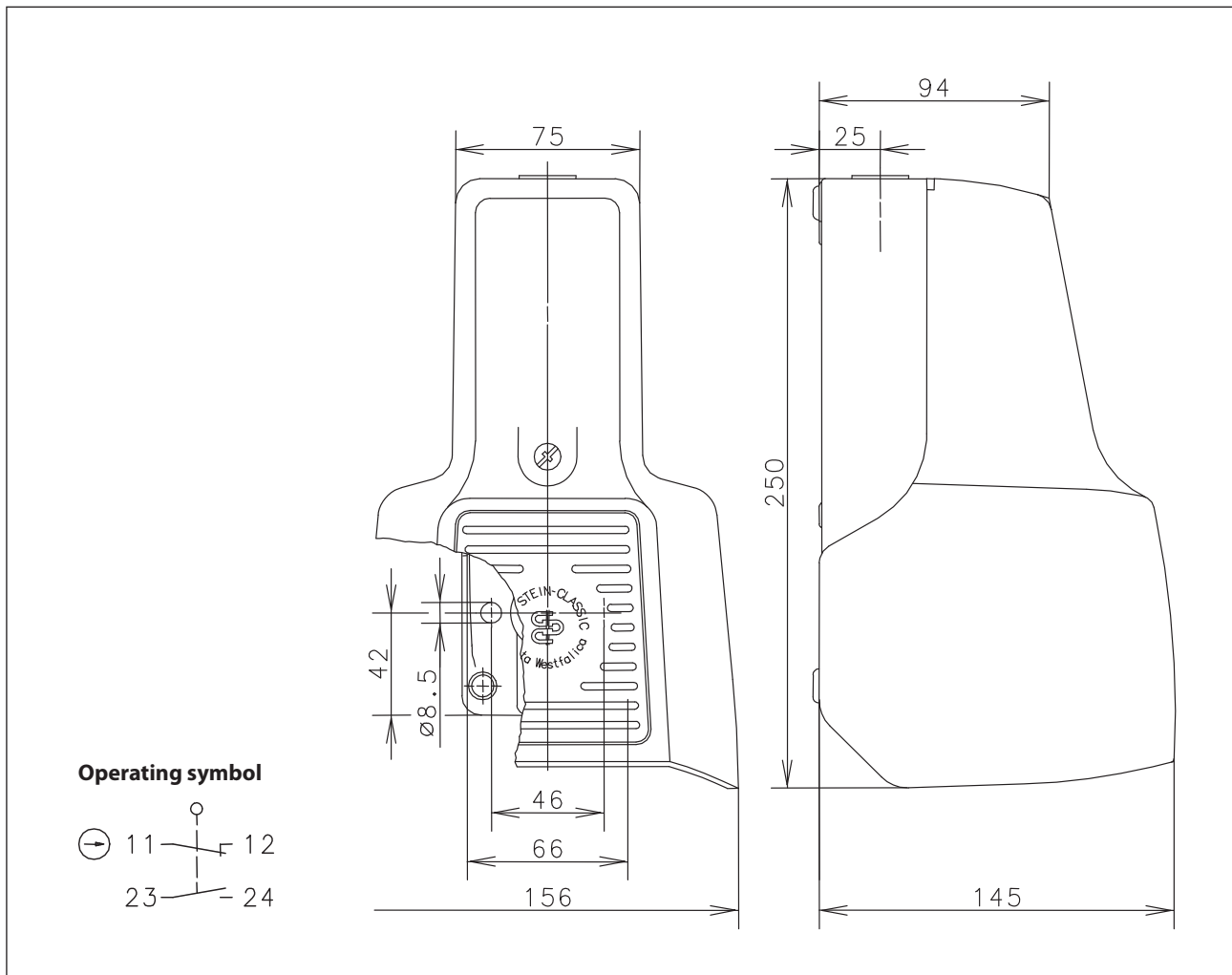

Electrical data		
Rated insulation voltage	U_i	400 V AC
Conv. thermal current	I_{the}	10 A
Rated operational voltage	U_e	240 V
Utilization category		AC-15, U_e 240 V / I_e 3 A, U_i 400 V
Direct opening action	\ominus	acc. to IEC/EN 60947-5-1, Annex K (pedal stop)
Short-circuit protective device		Fuse 10 A gG
Protection class		I

Mechanical Data	
Enclosure	AL
Protective guard (Accident protection cover UN)	AL
Actuator	Foot lever (PA)
Ambient air temperature	-30 °C ... +80 °C
Contact type	1 N.C. / 1 N.O. (Zb)
Operating force	≈ 10 N (pedal centre)
Mechanical life	10 x 10 ⁶ switching cycles
Switching frequency	≤ 50/min
Assembly	2 x M8
Connection	Screw connections (M3,5)
Number of connections	4
Protection ground	2 x M4
Conductor cross-sections	Solid: 0,5 ... 1,5 mm ² Litz wire with ferrules: 0,5 ... 1,5 mm ²
Cable entry size	1 x M20 x 1,5
Weight including protective guard	≈ 1,5 kg
Protection type	IP 65 acc. to IEC/EN 60529

ID for safety engineering	
B10d	20 x 10 ⁶ switching cycles

Standards	
	VDE 0660 T100, DIN EN 60947-1, IEC 60947-1
	VDE 0660 T200, DIN EN 60947-5-1, IEC 60947-5-1
	DIN EN ISO 13849-1

EU Conformity	
	acc. to directive 2006/42/EC

Approvals	
	DGUV
	cCSA _{US} A300 (same polarity)
	CCC

Notes	
Tapped holes not in use must be closed with blind plugs. The degree of protection (IP code) specified applies only to a properly closed accident protection cover and in connection with the appropriate cable glands or blind plugs.	